

# CORMACCH

87000 E  
A.S.C. plus

Quality Management  
ISO 9001  
[www.dekra-seel.com](http://www.dekra-seel.com)



[www.cormach.com](http://www.cormach.com)

# ... ABOUT ANCIENT

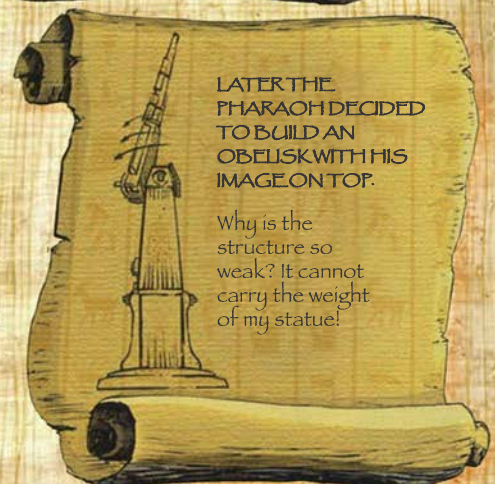
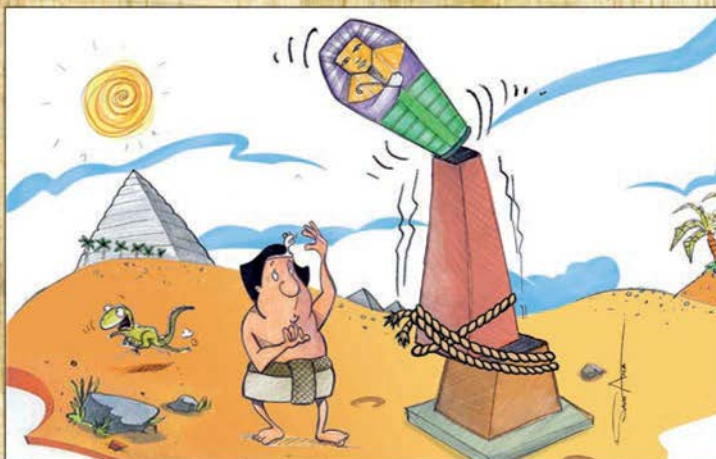
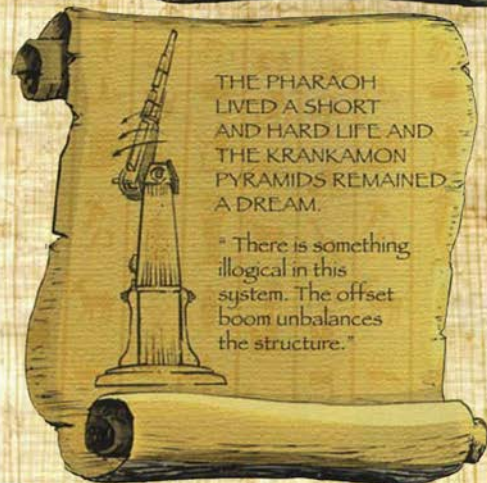
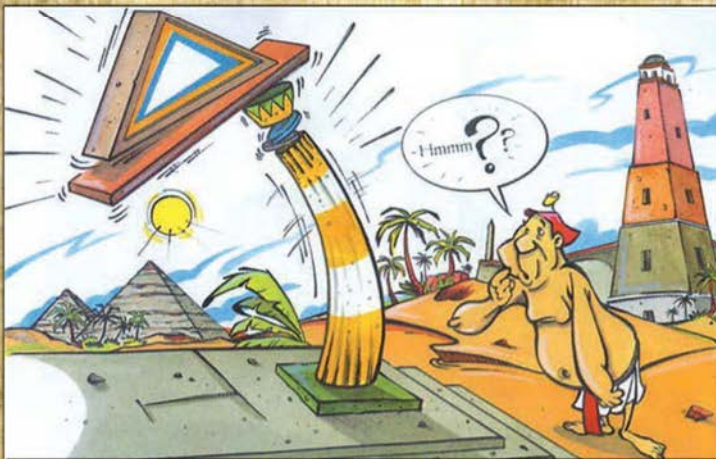
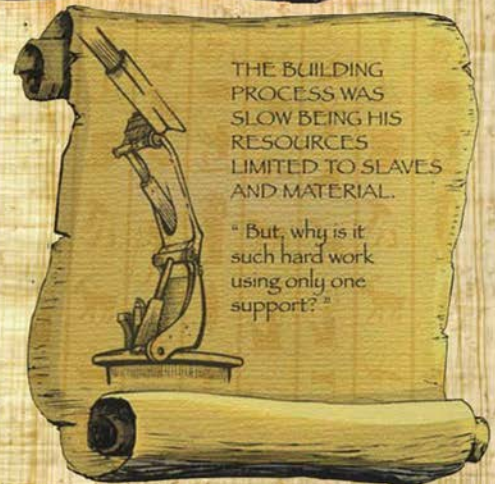
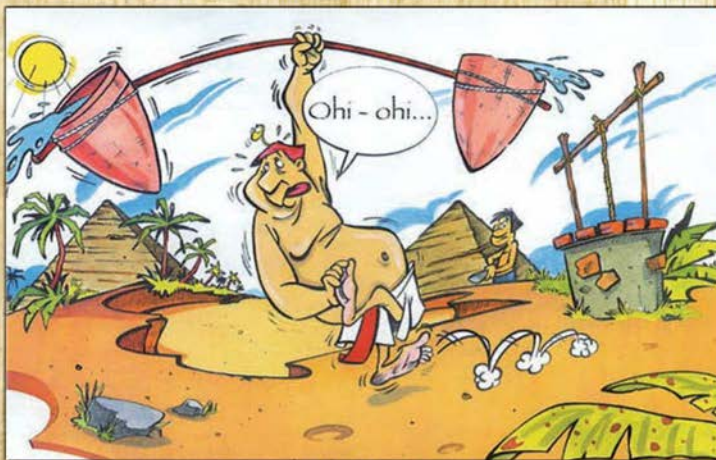
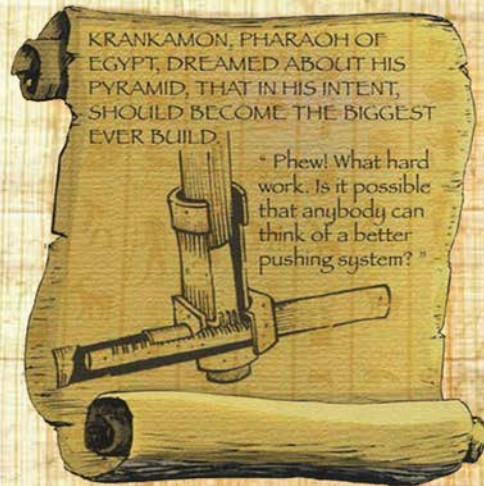

# EGYPT MANUSCRIPTS

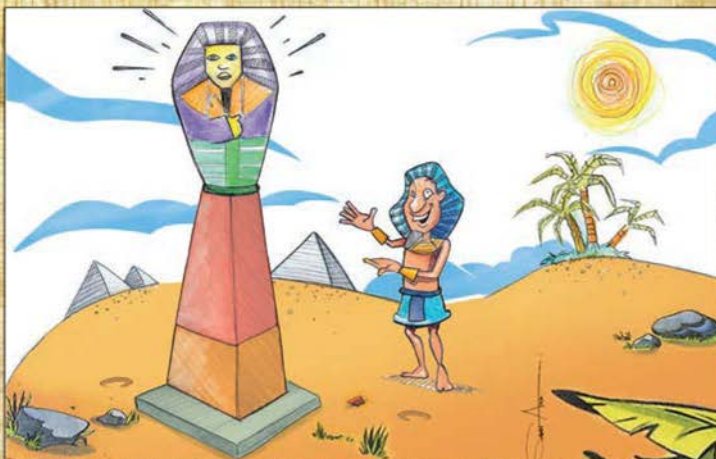
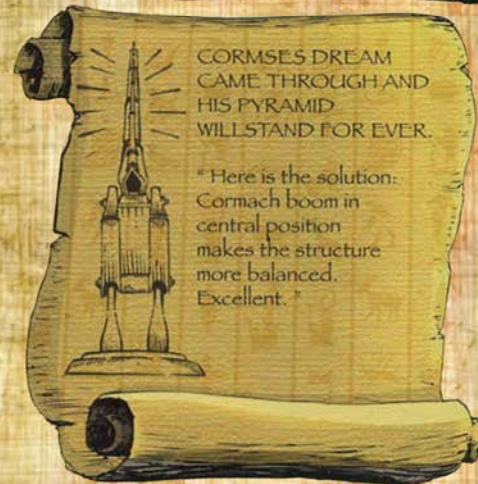
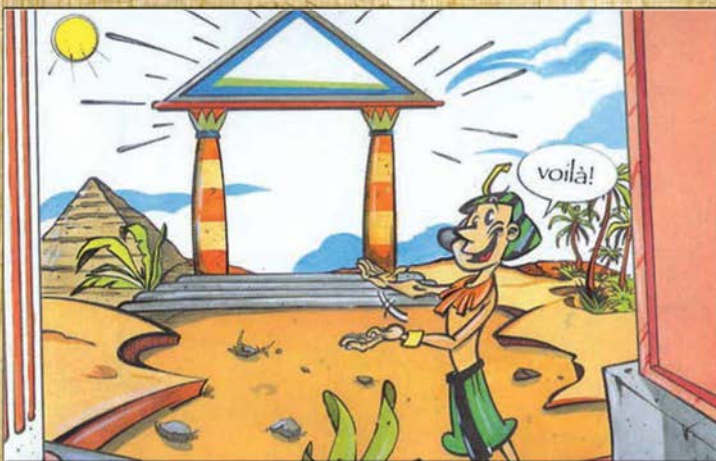
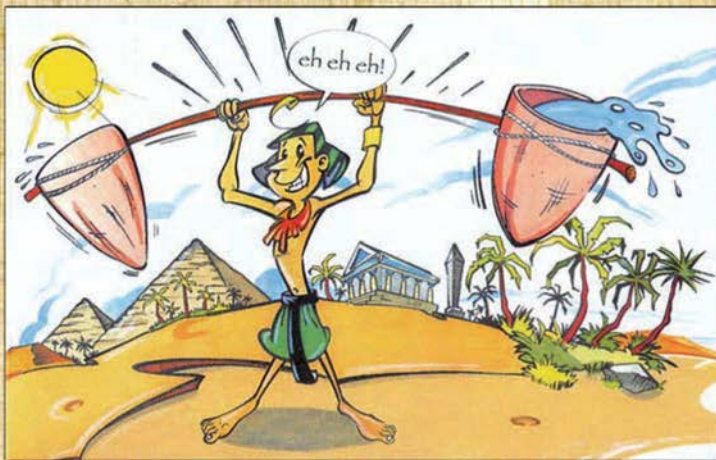
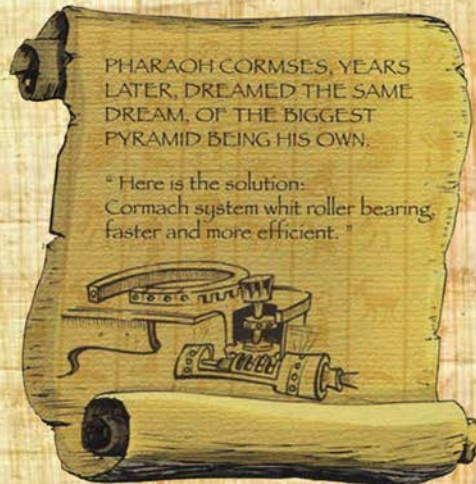

# 87000 E A.S.C. Plus

Angolo negativo tra 1° e 2° braccio (15 gradi)  
Negative angle between 1st and 2nd boom (15 degrees)  
Angle négatif entre 1ère et 2ème bras (15 degrés)  
Negativ Winkel zwischen ersten und zweiten Arm (15 Grad)

Doppi cilindri di sollevamento  
Double lifting cylinder  
Double vérin de levage  
Zwei Hubzylinder



Radiocomando di serie  
Radio remote control  
Radiocommande de série  
Funkfernsteuerung serienmäßig



Distributore proporzionale DANFOSS  
DANFOSS proportional control bank  
Distributeur proportionnelle DANFOSS  
DANFOSS proportionale Steuerventil



Articolazione con Biella e Puntone  
Articulation with link  
Articulation de bras  
Kniehebel am Knickarm

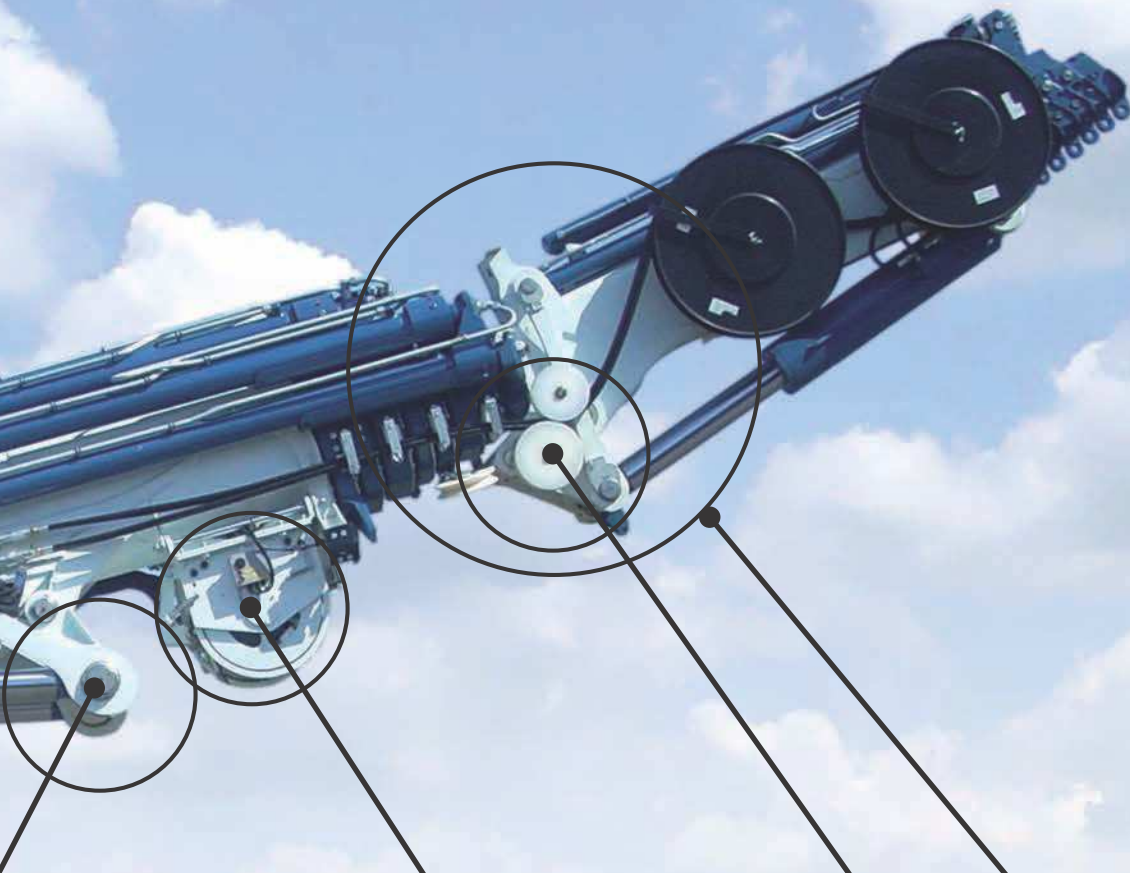

Angolo negativo tra prolunghe e JIB (10 gradi)  
Negative angle between extensions and JIB (10 degrees)  
Angle négatif entre extensions et JIB (10 degrés)  
Ausleger und JIB (10 Grad)



Scambiatore di calore  
Heat exchanger  
Echangeur de chaleur  
Ölkühler



Verricello tiro diretto 4000 daN - (OPZIONE) (2500 daN con JIB)  
4000 daN (2500 daN with JIB) winch on first line - (OPTIONAL)  
Treuil de tir direct 4000 daN (2500 daN avec JIB) - (OPTION)  
4000 daN (2500 daN JIB) Winde am ersten Seil - (AUF FRAGE)



Aggancio/Sgancio rapido JIB  
Quick connection and disconnection of the JIB  
Connexion rapide de JIB  
Schnellkupplung des Jib (für die Hydraulik: hydraulische Schnellkupplung)

# 87000 E A.S.C. Plus



Manometro e flash indicatori dello stato di carico della gru  
*Pressure gauge and flashing light indicating the load condition*  
*Indicateur de pression et signal lumineux, indiquant l'état de charge*  
*Manometer und optische Überlastanzeige*



Cilindro stabilizzatore ribaltabile 180° (OPZIONE)  
*180 degrees tilting stabilising cylinder (OPTIONAL)*  
*Cylindre stabilisateur escamotable 180 degrés (OPTION)*  
*Stützylinder kann 180° umgekippt werden (AUF FRAGE)*



Comandi stabilizzatori elettrici  
*Electric controls of the outriggers*  
*Commande stabilisateurs électriques*  
*Abstützungen elektronisch gesteuert (oder elektronisch überwacht?)*



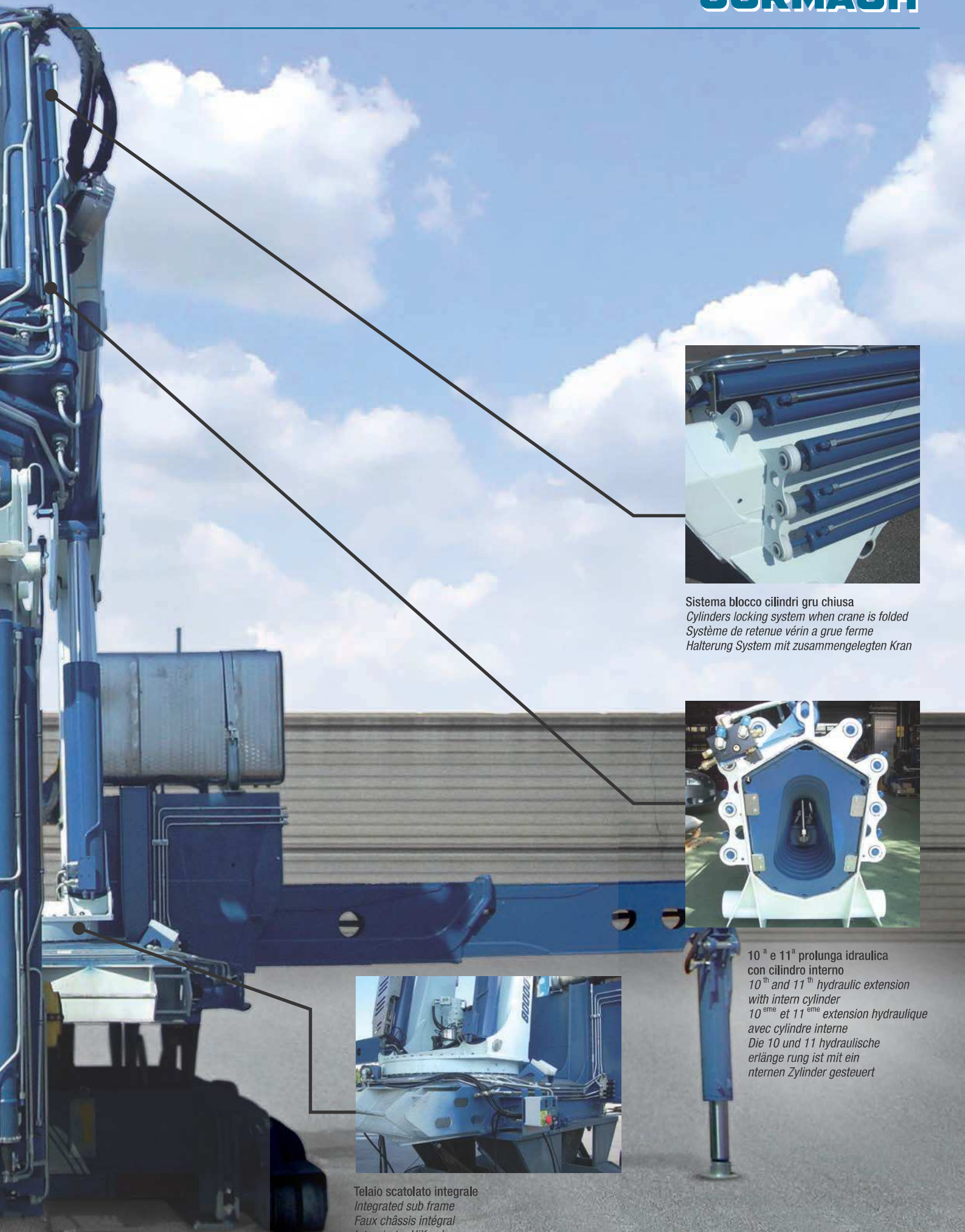

**Sistema blocco cilindri gru chiusa**  
*Cylinders locking system when crane is folded*  
*Système de retenue vérin a grue fermé*  
*Halterung System mit zusammengelegten Kran*



**10<sup>a</sup> e 11<sup>a</sup> prolunga idraulica con cilindro interno**  
*10<sup>th</sup> and 11<sup>th</sup> hydraulic extension with intern cylinder*  
*10<sup>ème</sup> et 11<sup>ème</sup> extension hydraulique avec cylindre interne*  
*Die 10 und 11 hydraulische erlänge rung ist mit ein nternen Zylinder gesteuert*



**Telaio scatolato integrale**  
*Integrated sub frame*  
*Faux châssis intégral*  
*Integrierter Hilfsrahmen*

# 87000 E A.S.C. Plus

## 87000 E2

## 87000 E3

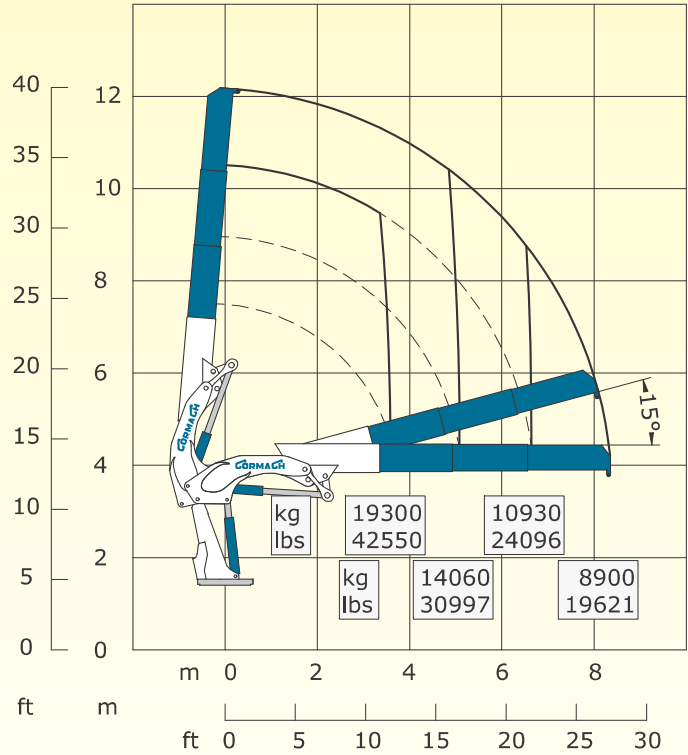
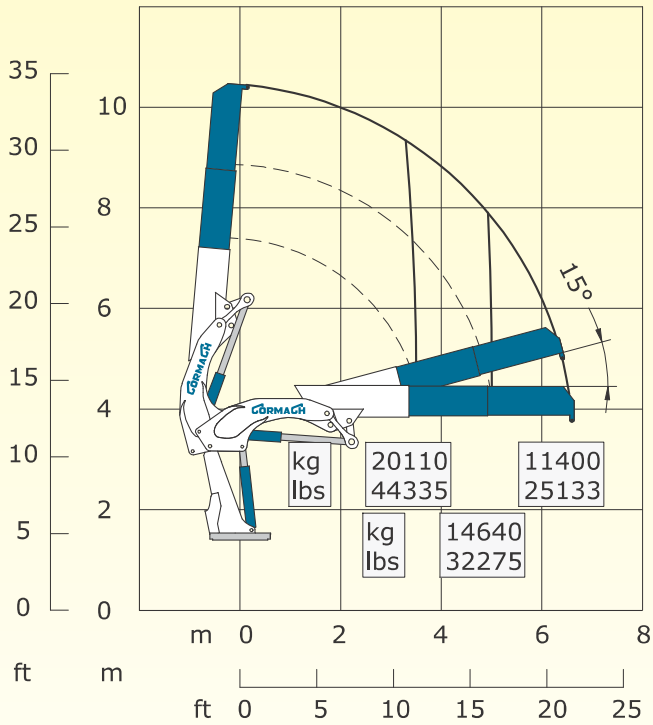

### STANDARD

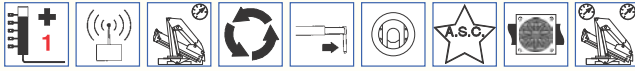

### OPTIONAL



### STANDARD

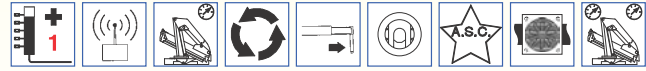

### OPTIONAL

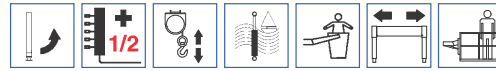

E2			E3	
87000 daN*m	629393 Lb*ft	Momento statico massimo al perno torretta – Max. static moment at the turret pin Moment statique max. a l'axe de la tourelle – Max. statisches ubmoment am kranseulenbolzen	87000 daN*m	629393 Lb*ft
6.55 m	21' 6"	Sbraccio idraulico – Hydraulic boom length Longueur du bras hydraulique – Hydraulic reichweite	8.27 m	27' 1"
		Sbraccio con prolunghe manuali – Boom length with manual extension Longueur du bras avec rallonges manuelles - Auslegerlänge		
8400 daN*m	60769 Lb*ft	Coppia di rotazione – Slew torque – Moment de rotation – Drehmoment	8400 daN*m	60769 Lb*ft
90 sec 360°	90 sec 360°	Tempo di rotazione – Slewing speed – Temp de rotation – Schwenkgeschwindigkeit	90 sec 360°	90 sec 360°
3625+2875 mm	11' 11" + 9' 5"	Uscita stabilizzatori – Outriggers extension – Sortie de bequilles – Breite der Abstützung	3625+2875 mm	11' 11" + 9' 5"
8850 mm	29' 0"	Larghezza stabilizzatori – Outriggers width – Largeur des bequilles – Gesamtbreite der Abstützung	8850 mm	29' 0"
1842 mm	6' 1"	Lunghezza – Length – Longueur - Gesamtbreite	1842 mm	6' 1"
2540 mm	8' 4"	Larghezza – Width – Largeur - Breite	2540 mm	8' 4"
2650 mm	8' 8"	Altezza – Height – Hauteur - Höhe	2650 mm	8' 8"
7180 kg	15830 lbs	Peso (senza olio e montaggio) – Weight (without oil and fitting) Poids (sans huile et montage – Gewicht (ohne Öl und ohne)	7500 kg	16535 lbs
100 l/min	26 us gal/min	Portata pompa – Pump delivery – Capacité de la pompe - Pumpenleistung	100 l/min	26 us gal/min
310 bar	4408 psi	Pressione – Pressure – Pression - Druck	310 bar	4408 psi
260 l	69 us gal	Capacità serbatoio olio – Oil tank capacity – Capacité du réservoir de l'huile – Öl tank inhalt	260 l	69 us gal



## 87000 E4

## 87000 E5

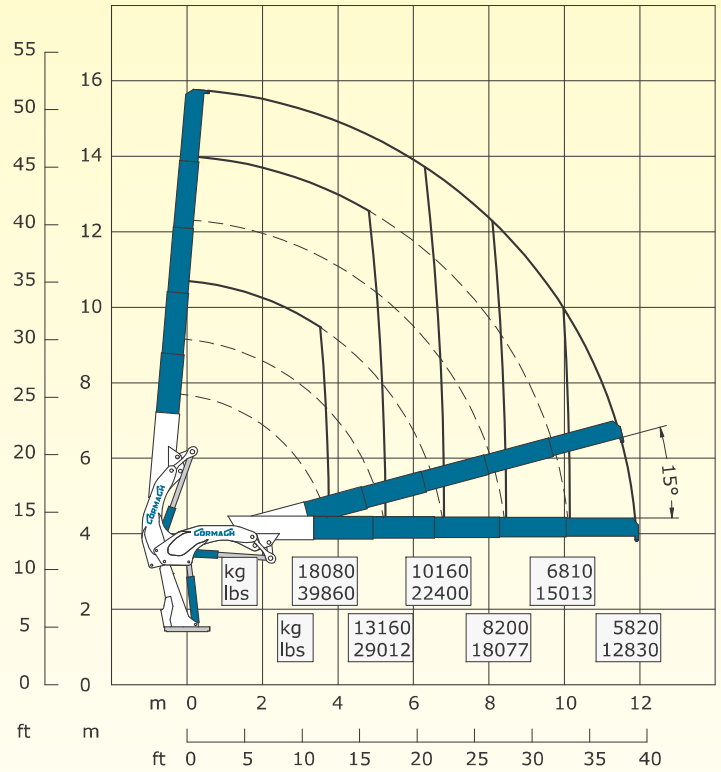
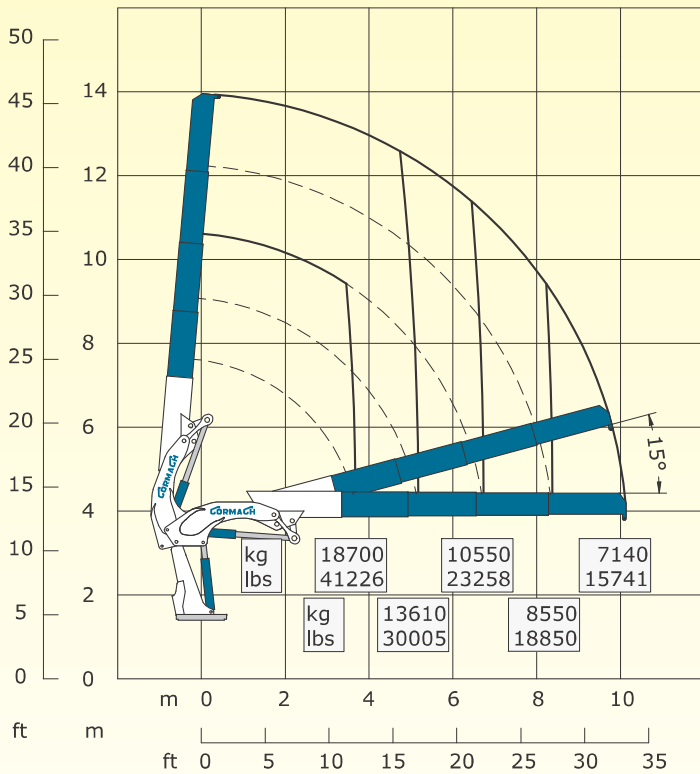

### STANDARD

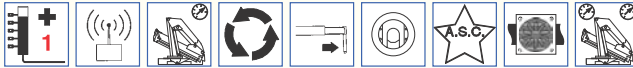

### OPTIONAL



### STANDARD

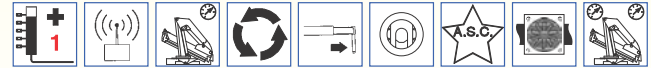

### OPTIONAL

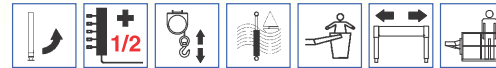

E4			E5	
87000 daN*m	629393 Lb*ft	Momento statico massimo al perno torretta – Max. static moment at the turret pin Moment statique max. a l'axe de la tourelle – Max. statisches ubmoment am kranseulenbolzen	87000 daN*m	629393 Lb*ft
10.04 m	32' 11"	Sbraccio idraulico – Hydraulic boom length Longueur du bras hydraulique – Hydraulic reichweite	11.87 m	39' 0"
		Sbraccio con prolunghe manuali – Boom length with manual extension Longueur du bras avec rallonges manuelles – Auslegerlänge		
8400 daN*m	60769 Lb*ft	Coppia di rotazione – Slew torque – Moment de rotation – Drehmoment	8400 daN*m	60769 Lb*ft
90 sec 360°	90 sec 360°	Tempo di rotazione – Slewing speed – Temp de rotation – Schwenkgeschwindigkeit	90 sec 360°	90 sec 360°
3625+2875 mm	11' 11" + 9' 5"	Uscita stabilizzatori – Outriggers extension – Sortie de bequilles – Breite der Abstützung	3625+2875 mm	11' 11" + 9' 5"
8850 mm	29' 0"	Larghezza stabilizzatori – Outriggers width – Largeur des bequilles – Gesamtbreite der Abstützung	8850 mm	29' 0"
1842 mm	6' 1"	Lunghezza – Length – Longueur – Gesamtbreite	1842 mm	6' 1"
2540 mm	8' 4"	Larghezza – Width – Largeur – Breite	2540 mm	8' 4"
2650 mm	8' 8"	Altezza – Height – Hauteur – Höhe	2650 mm	8' 8"
7800 kg	17200 lbs	Peso (senza olio e montaggio) – Weight (without oil and fitting) Poids (sans huile et montage – Gewicht (ohne Öl und ohne)	8100 kg	17860 lbs
100 l/min	26 us gal/min	Portata pompa – Pump delivery – Capacité de la pompe – Pumpenleistung	100 l/min	26 us gal/min
310 bar	4408 psi	Pressione – Pressure – Pression – Druck	310 bar	4408 psi
260 l	69 us gal	Capacità serbatoio olio – Oil tank capacity – Capacité du réservoir de l'huile – Öl tank inhalt	260 l	69 us gal

# 87000 E A.S.C. Plus

## 87000 E6

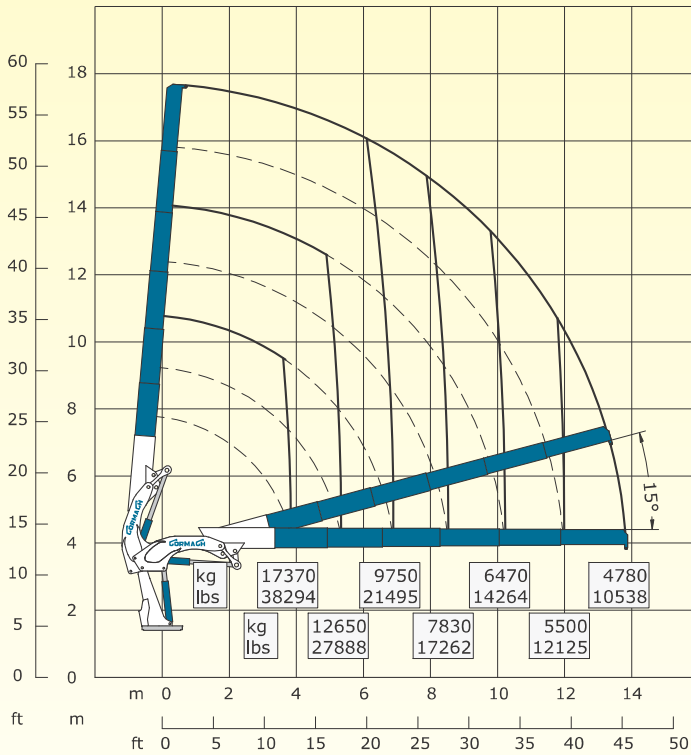

## 87000 E7

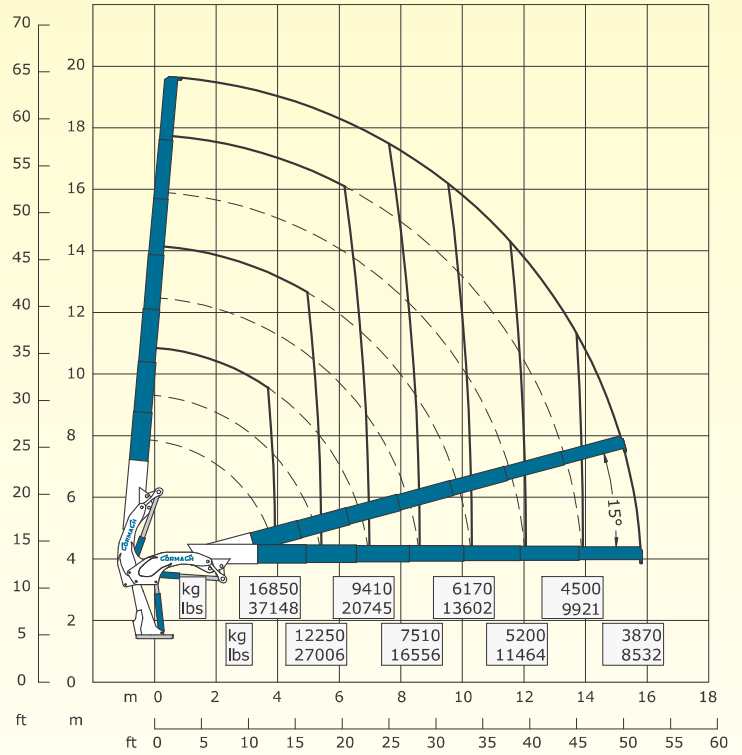

### STANDARD

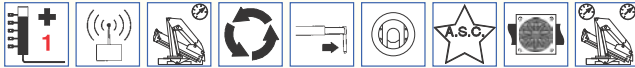

### OPTIONAL



### STANDARD



### OPTIONAL

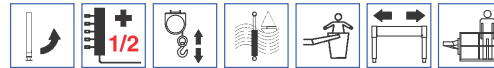

E6			E7	
87000 daN*m	629393 Lb*ft	Momento statico massimo al perno torretta – Max. static moment at the turret pin Moment statique max. a l'axe de la tourelle – Max. statisches ubmoment am kransaulenbolzen	87000 daN*m	629393 Lb*ft
13.80 m	45' 3"	Sbraccio idraulico – Hydraulic boom length Longueur du bras hydraulique – Hydraulic reichweite	15.77 m	51' 9"
		Sbraccio con prolunghe manuali – Boom length with manual extension Longueur du bras avec rallonges manuelles – Auslegerlänge		
8400 daN*m	60769 Lb*ft	Coppia di rotazione – Slew torque – Moment de rotation – Drehmoment	8400 daN*m	60769 Lb*ft
90 sec 360°	90 sec 360°	Tempo di rotazione – Slewing speed – Temp de rotation – Schwenkgeschwindigkeit	90 sec 360°	90 sec 360°
3625+2875 mm	11' 11" + 9' 5"	Uscita stabilizzatori – Outriggers extension – Sortie de bequilles – Breite der Abstützung	3625+2875 mm	11' 11" + 9' 5"
8850 mm	29' 0"	Larghezza stabilizzatori – Outriggers width – Largeur des bequilles – Gesamtbreite der Abstützung	8850 mm	29' 0"
1842 mm	6' 1"	Lunghezza – Length – Longueur – Gesamtbreite	1842 mm	6' 1"
2540 mm	8' 4"	Larghezza – Width – Largeur – Breite	2540 mm	8' 4"
2650 mm	8' 8"	Altezza – Height – Hauteur – Höhe	2650 mm	8' 8"
8400 kg	18519 lbs	Peso (senza olio e montaggio) – Weight (without oil and fitting) Poids (sans huile et montage – Gewicht (ohne Öl und ohne)	8680 kg	19136 lbs
100 l/min	26 us gal/min	Portata pompa – Pump delivery – Capacité de la pompe – Pumpenleistung	100 l/min	26 us gal/min
310 bar	4408 psi	Pressione – Pressure – Pression – Druck	310 bar	4408 psi
260 l	69 us gal	Capacità serbatoio olio – Oil tank capacity – Capacité du réservoir de l'huile – Öl tank inhalt	260 l	69 us gal

# 87000 E8

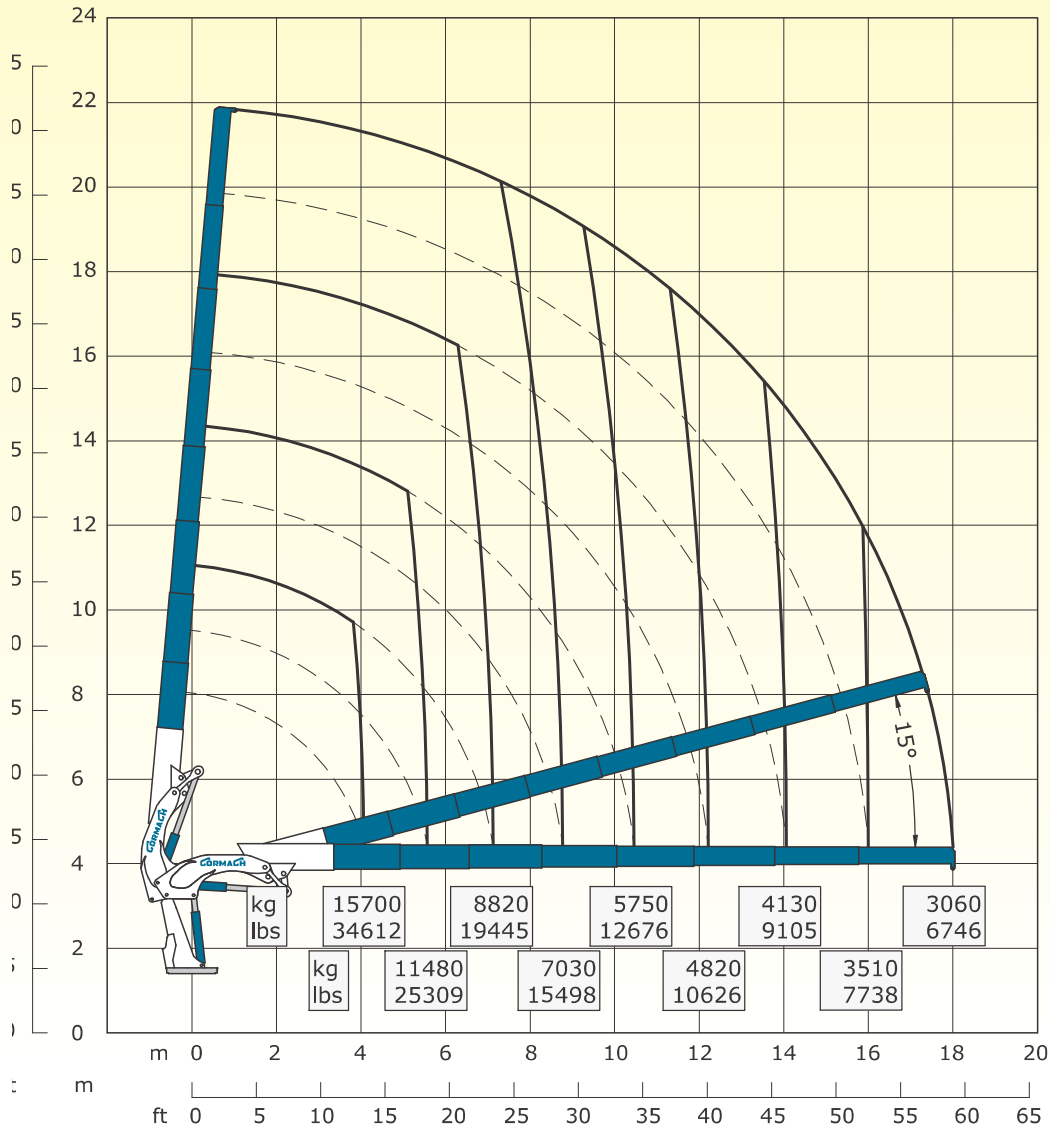

E8		
<b>87000 daN*m</b>	<b>629393 Lb*ft</b>	Momento statico massimo al perno torretta – Max. static moment at the turret pin Moment statique max. a l'axe de la tourelle – Max. statisches ubmoment am kranseulenbolzen
<b>18.00 m</b>	<b>59' 0"</b>	Sbraccio idraulico – Hydraulic boom length Longueur du bras hydraulique – Hydraulic reichweite
		Sbraccio con prolunghe manuali – Boom length with manual extension Longueur du bras avec rallonges manuelles - Auslegerlänge
<b>8400 daN*m</b>	<b>60769 Lb*ft</b>	Coppia di rotazione – Slew torque – Moment de rotation – Drehmoment
<b>90 sec 360°</b>	<b>90 sec 360°</b>	Tempo di rotazione – Slewing speed – Temp de rotation – Schwenkgeschwindigkeit
<b>3625+2875 mm</b>	<b>11' 11" + 9' 5"</b>	Uscita stabilizzatori – Outriggers extension – Sortie de bequilles – Breite der Abstützung
<b>8850 mm</b>	<b>29' 0"</b>	Larghezza stabilizzatori – Outriggers width – Largeur des bequilles – Gesamtbreite der Abstützung
<b>1842 mm</b>	<b>6' 1"</b>	Lunghezza – Length – Longueur – Gesamtbreite
<b>2540 mm</b>	<b>8' 4"</b>	Larghezza – Width – Largeur - Breite
<b>2650 mm</b>	<b>8' 8"</b>	Altezza – Height – Hauteur - Höhe
<b>8980 kg</b>	<b>19798 lbs</b>	Peso (senza olio e montaggio) – Weight (without oil and fitting) Poids (sans huile et montage – Gewicht (ohne Öl und ohne)
<b>100 l/min</b>	<b>26 us gal/min</b>	Portata pompa – Pump delivery – Capacité de la pompe - Pumpenleistung
<b>310 bar</b>	<b>4408 psi</b>	Pressione – Pressure – Pression - Druck
<b>260 l</b>	<b>69 us gal</b>	Capacità serbatoio olio – Oil tank capacity – Capacité du réservoir de l'huile – Öl tank inhalt

### STANDARD



### OPTIONAL

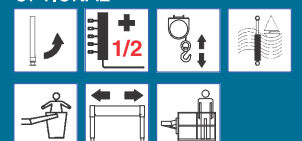

# 87000 E A.S.C. Plus

## 87000 E9

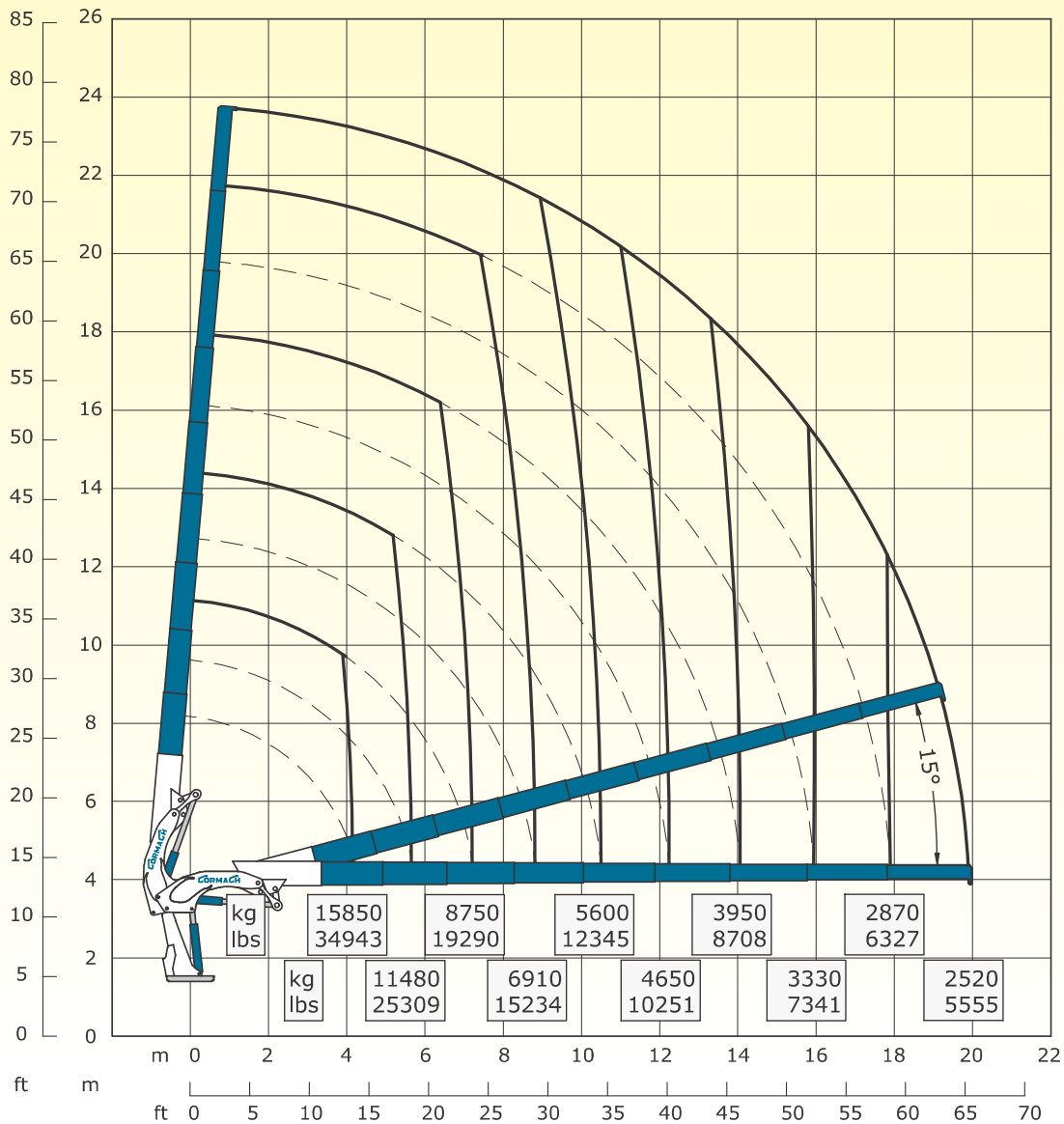

E9		
87000 daN*m	629393 Lb*ft	Momento statico massimo al perno torretta – Max. static moment at the turret pin Moment statique max. a l'axe de la tourelle – Max. statisches ubmoment am kranseulenbolzen
19.94 m	65' 5"	Sbraccio idraulico – Hydraulic boom length Longueur du bras hydraulique – Hydraulic reichweite
		Sbraccio con prolunghe manuali – Boom length with manual extension Longueur du bras avec rallonges manuelles - Auslegerlänge
8400 daN*m	60769 Lb*ft	Coppia di rotazione – Slew torque – Moment de rotation – Drehmoment
90 sec 360°	90 sec 360°	Tempo di rotazione – Slewing speed – Temp de rotation – Schwenkgeschwindigkeit
3625+2875 mm	11' 11" + 9' 5"	Uscita stabilizzatori – Outriggers extension – Sortie de bequilles – Breite der Abstützung
8850 mm	29' 0"	Larghezza stabilizzatori – Outriggers width – Largeur des bequilles – Gesamtbreite der Abstützung
1842 mm	6' 1"	Lunghezza – Length – Longueur – Gesamtbreite
2540 mm	8' 4"	Larghezza – Width – Largeur - Breite
2650 mm	8' 8"	Altezza – Height – Hauteur - Höhe
9210 kg	20305 lbs	Peso (senza olio e montaggio) – Weight (without oil and fitting) Poids (sans huile et montage – Gewicht (ohne Öl und ohne)
100 l/min	26 us gal/min	Portata pompa – Pump delivery – Capacité de la pompe - Pumpenleistung
310 bar	4408 psi	Pressione – Pressure – Pression - Druck
260 l	69 us gal	Capacità serbatoio olio – Oil tank capacity – Capacité du réservoir de l'huile – Öl tank inhalt

### STANDARD



### OPTIONAL

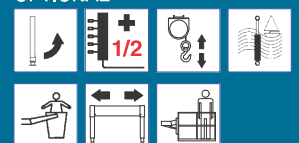

# 87000 E11

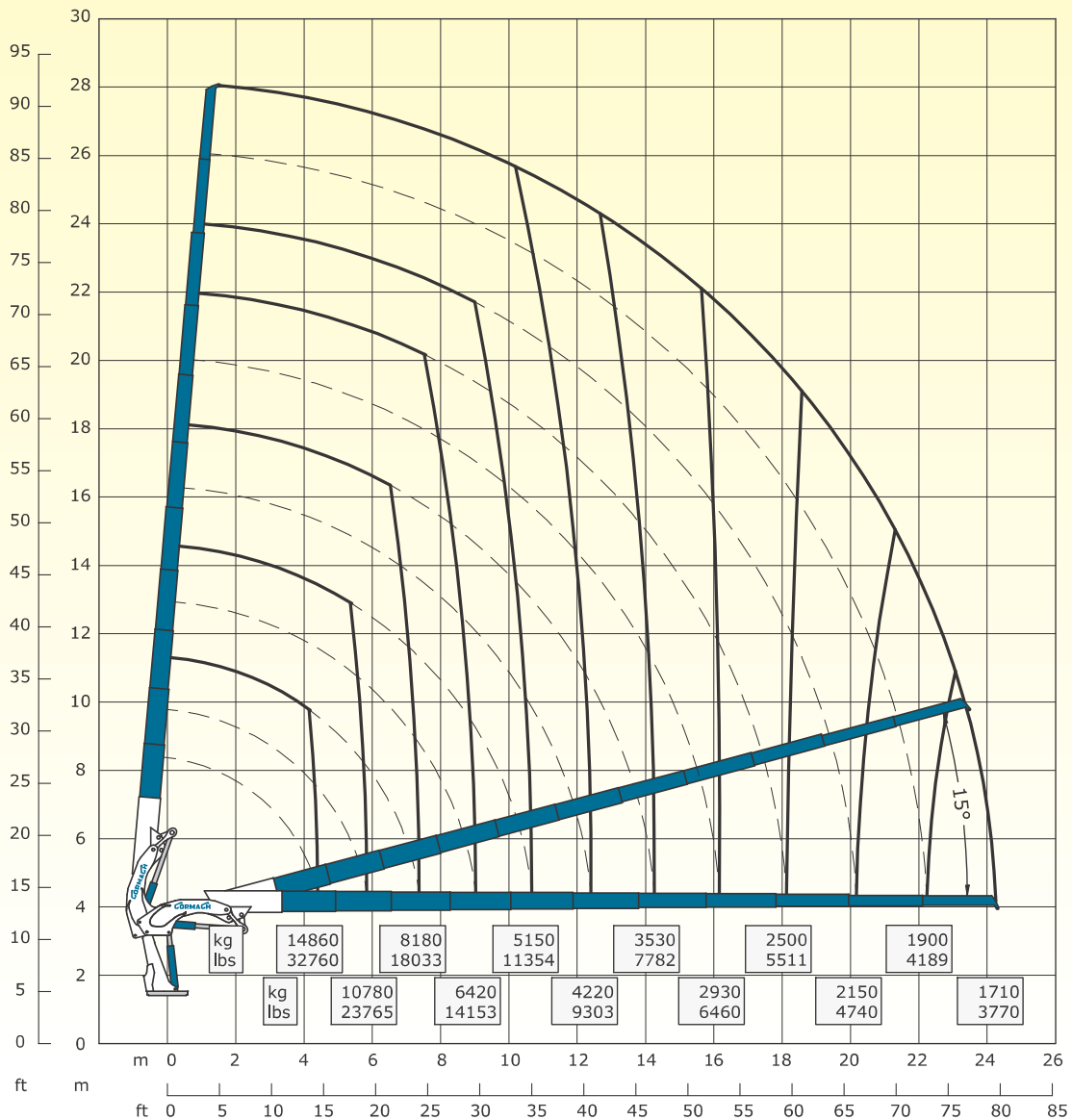

E11		
<b>87000 daN*m</b>	<b>629393 Lb*ft</b>	Momento statico massimo al perno torretta – Max. static moment at the turret pin Moment statique max. a l'axe de la tourelle – Max. statisches ubmoment am kranseulenbolzen
<b>24.30 m</b>	<b>79' 8"</b>	Sbraccio idraulico – Hydraulic boom length Longueur du bras hydraulique – Hydraulic reichweite
		Sbraccio con prolunghe manuali – Boom length with manual extension Longueur du bras avec rallonges manuelles - Auslegerlänge
<b>8400 daN*m</b>	<b>60769 Lb*ft</b>	Coppia di rotazione – Slew torque – Moment de rotation – Drehmoment
<b>90 sec 360°</b>	<b>90 sec 360°</b>	Tempo di rotazione – Slewing speed – Temp de rotation – Schwenkgeschwindigkeit
<b>3625+2875 mm</b>	<b>11' 11" + 9' 5"</b>	Uscita stabilizzatori – Outriggers extension – Sortie de bequilles – Breite der Abstützung
<b>8850 mm</b>	<b>29' 0"</b>	Larghezza stabilizzatori – Outriggers width – Largeur des bequilles – Gesamtbreite der Abstützung
<b>1842 mm</b>	<b>6' 1"</b>	Lunghezza – Length – Longueur – Gesamtbreite
<b>2540 mm</b>	<b>8' 4"</b>	Larghezza – Width – Largeur - Breite
<b>2650 mm</b>	<b>8' 8"</b>	Altezza – Height – Hauteur - Höhe
<b>9600 kg</b>	<b>21164 lbs</b>	Peso (senza olio e montaggio) – Weight (without oil and fitting) Poids (sans huile et montage – Gewicht (ohne Öl und ohne)
<b>100 l/min</b>	<b>26 us gal/min</b>	Portata pompa – Pump delivery – Capacité de la pompe - Pumpenleistung
<b>310 bar</b>	<b>4408 psi</b>	Pressione – Pressure – Pression - Druck
<b>260 l</b>	<b>69 us gal</b>	Capacità serbatoio olio – Oil tank capacity – Capacité du réservoir de l'huile – Öl tank inhalt

### STANDARD



### OPTIONAL

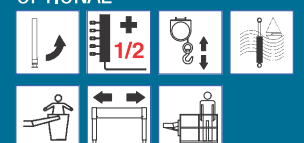

# 87000 E A.S.C. Plus

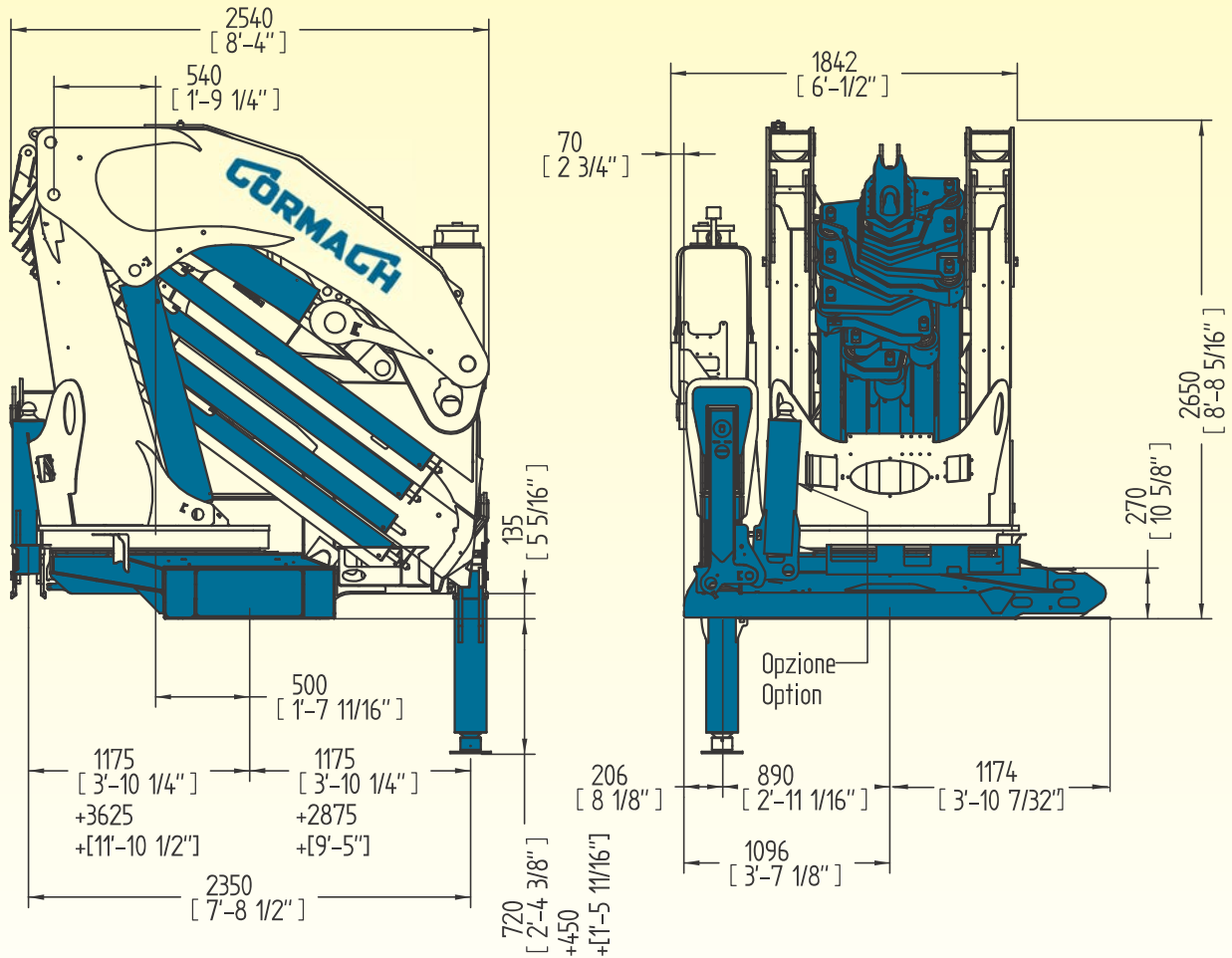

## STANDARD



**Comando supplementare non attivato (1)**  
Additional free section not activated (1)  
Section du distributeur pas activé (1)  
Zusätzlicher steuerschieber (1)

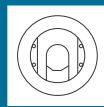

**Piastre di appoggio maggiorate**  
Large ground plates  
Plaques stabilisateurs  
Bodenplatten



**Radiocomando**  
Radio remote control  
Radiocommandes  
Funkfernsteuerung



**Automatic Speed Control**  
Automatic Speed Control  
Automatic Speed Control  
Automatic Speed Control



**Limitatore di momento**  
Load limiting device  
Limiteur de charge  
Überlastabschal tungssystem



**Scambiatore di calore**  
Oil cooler  
Echangeur de chaleur  
Ölkühler



**Rotazione continua**  
Continuous rotation  
Rotation continue  
Endlos schwenkwerk



**Doppio limitatore di momento**  
Double load limiting device  
Double limiteur de charge  
Doppel Überlastabschal tungssystem

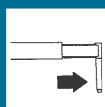

**Stabilizzatori gru base estendibili idraulicamente**  
Outriggers with hydraulic  
Stabilisateurs avec extension hydraulique  
Hydraulisch ausfahrbare stützen

## OPTIONAL



**Stabilizzatori gru base girevoli**  
Tilt up outriggers  
Bequilles tournants  
Drehbare stützen

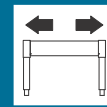

**Traversa ausiliaria estendibile**  
Additional outriggers with lateral extension  
Stabilisateur supplémentaires avec élargissement  
Ausfahrbare zusatz- stützen



**Comando supplementare attivato (1/2)**  
Additional function (1/2)  
Section du distributeur activée (1/2)  
Zusatzfunktion (1/2)

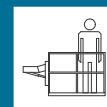

**Piattaforma autolivellante**  
Self leveling platform  
Plateforme auto nivelante  
Arbeitskorb mit automatische Ausgleich Analoge



**Verricello**  
Winch  
Treuil  
Seilwinde



**Trattamento marino della gru**  
Marine treatment of the crane  
Traitement marine de la grue  
Marine behandlung des kranes



**Cestello**  
Basket  
Nacelle  
Personenkorb

# 87000 E8F183

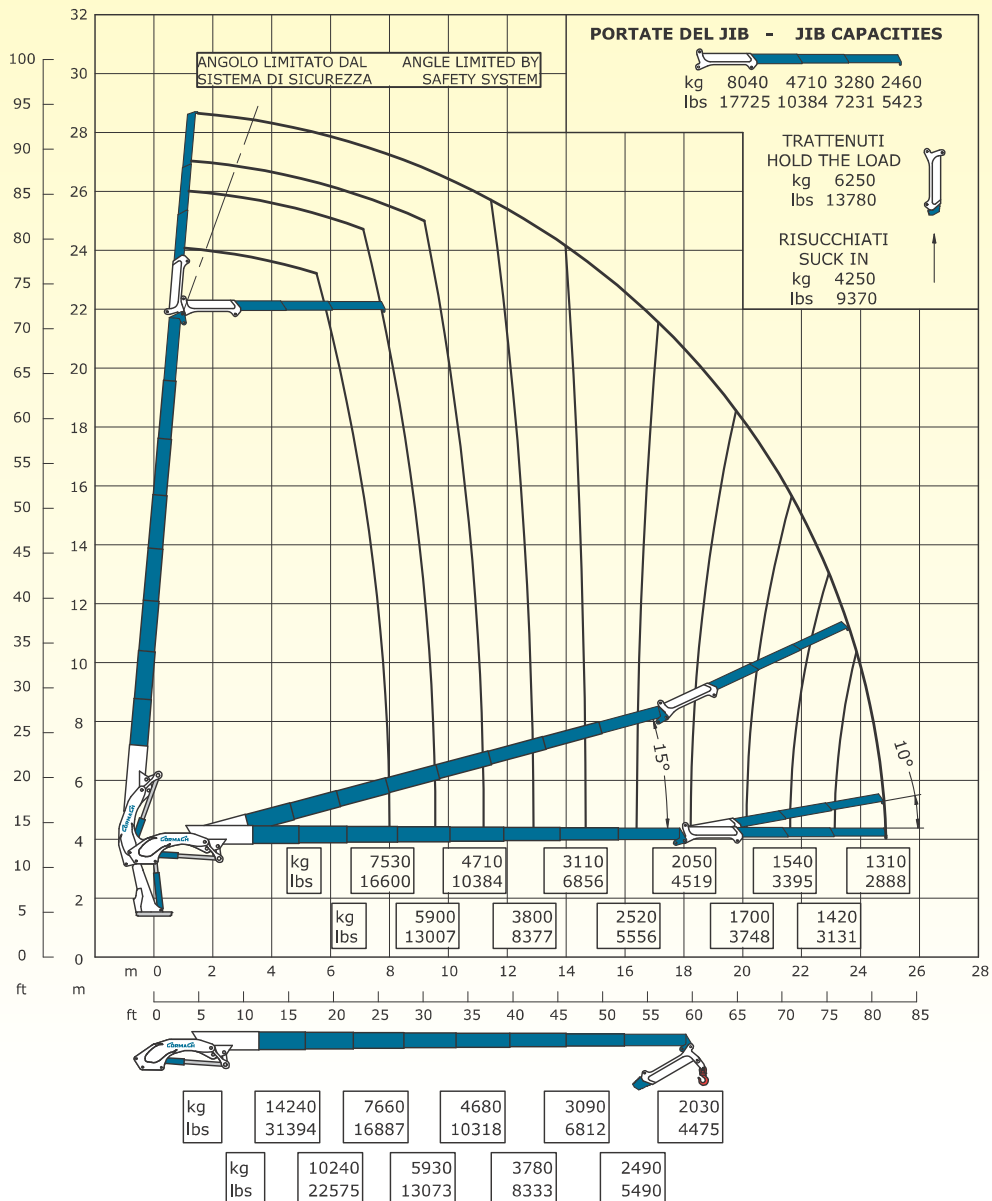

E8F183		
87000 daN*m	629393 Lb*ft	Momento statico massimo al perno torretta – Max. static moment at the turret pin Moment statique max. a l'axe de la tourelle – Max. statisches ubmoment am kranseulenbolzen
24.84 m	81' 5"	Sbraccio idraulico – Hydraulic boom length Longueur du bras hydraulique – Hydraulic reichweite
		Sbraccio con prolunghe manuali – Boom length with manual extension Longueur du bras avec rallonges manuelles - Auslegerlänge
8400 daN*m	60769 Lb*ft	Coppia di rotazione – Slew torque – Moment de rotation – Drehmoment
90 sec 360°	90 sec 360°	Tempo di rotazione – Slewing speed – Temp de rotation – Schwenkgeschwindigkeit
3625+2875 mm	11' 11" + 9' 5"	Uscita stabilizzatori – Outriggers extension – Sortie de bequilles – Breite der Abstützung
8850 mm	29' 0"	Larghezza stabilizzatori – Outriggers width – Largeur des bequilles – Gesamtbreite der Abstützung
1842 mm	6' 1"	Lunghezza – Length – Longueur – Gesamtbreite
2550 mm	8' 4"	Larghezza – Width – Largeur - Breite
2950 mm	9' 8"	Altezza – Height – Hauteur - Höhe
10120 kg	22311 lbs	Peso (senza olio e montaggio) – Weight (without oil and fitting) Poids (sans huile et montage – Gewicht (ohne Öl und ohne)
100 l/min	26 us gal/min	Portata pompa – Pump delivery – Capacité de la pompe - Pumpenleistung
310 bar	4408 psi	Pressione – Pressure – Pression - Druck
260 l	69 us gal	Capacità serbatoio olio – Oil tank capacity – Capacité du réservoir de l'huile – Öl tank inhalt

## STANDARD

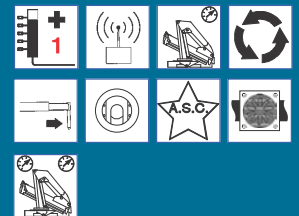

## OPTIONAL

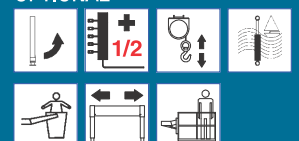

# 87000 E A.S.C. Plus

## 87000 E8F184

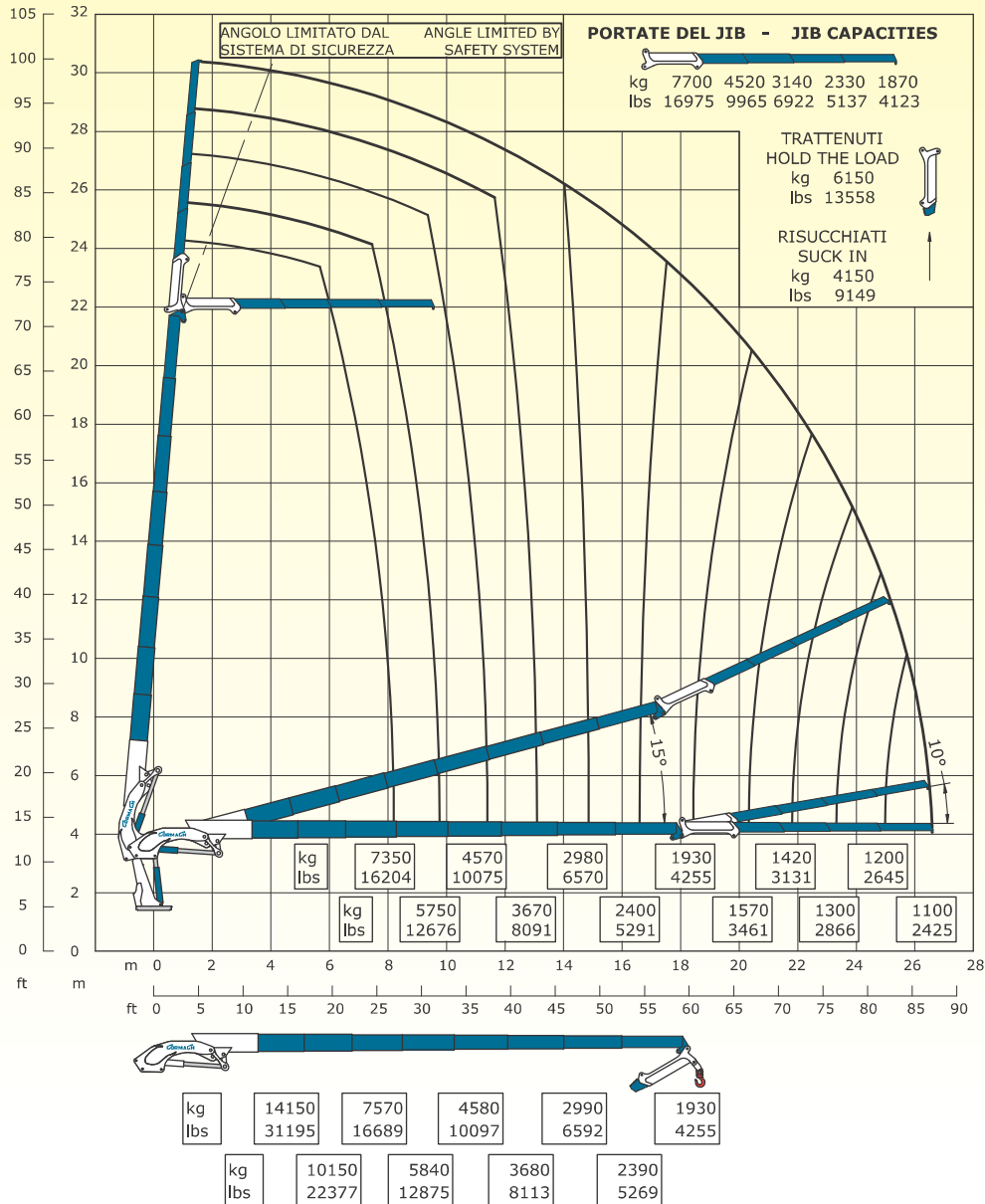

E8F184		
87000 daN*m	629393 Lb*ft	Momento statico massimo al perno torretta – Max. static moment at the turret pin Moment statique max. a l'axe de la tourelle – Max. statisches ubmoment am kranseulenbolzen
26.57 m	87' 2"	Sbraccio idraulico – Hydraulic boom length Longueur du bras hydraulique – Hydraulic reichweite
		Sbraccio con prolunghe manuali – Boom length with manual extension Longueur du bras avec rallonges manuelles – Auslegerlänge
8400 daN*m	60769 Lb*ft	Coppia di rotazione – Slew torque – Moment de rotation – Drehmoment
90 sec 360°	90 sec 360°	Tempo di rotazione – Slewing speed – Temp de rotation – Schwenkgeschwindigkeit
3625+2875 mm	11' 11" + 9' 5"	Uscita stabilizzatori – Outriggers extension – Sortie de bequilles – Breite der Abstützung
8850 mm	29' 0"	Larghezza stabilizzatori – Outriggers width – Largeur des bequilles – Gesamtbreite der Abstützung
1842 mm	6' 1"	Lunghezza – Length – Longueur – Gesamtbreite
2550 mm	8' 4"	Larghezza – Width – Largeur – Breite
2950 mm	9' 8"	Altezza – Height – Hauteur – Höhe
10230 kg	22553 lbs	Peso (senza olio e montaggio) – Weight (without oil and fitting) Poids (sans huile et montage – Gewicht (ohne Öl und ohne)
100 l/min	26 us gal/min	Portata pompa – Pump delivery – Capacité de la pompe – Pumpenleistung
310 bar	4408 psi	Pressione – Pressure – Pression – Druck
260 l	69 us gal	Capacità serbatoio olio – Oil tank capacity – Capacité du réservoir de l'huile – Öl tank inhalt

### STANDARD



### OPTIONAL

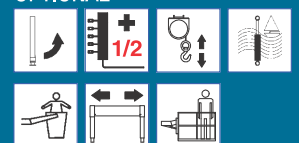



# 87000 E8F186

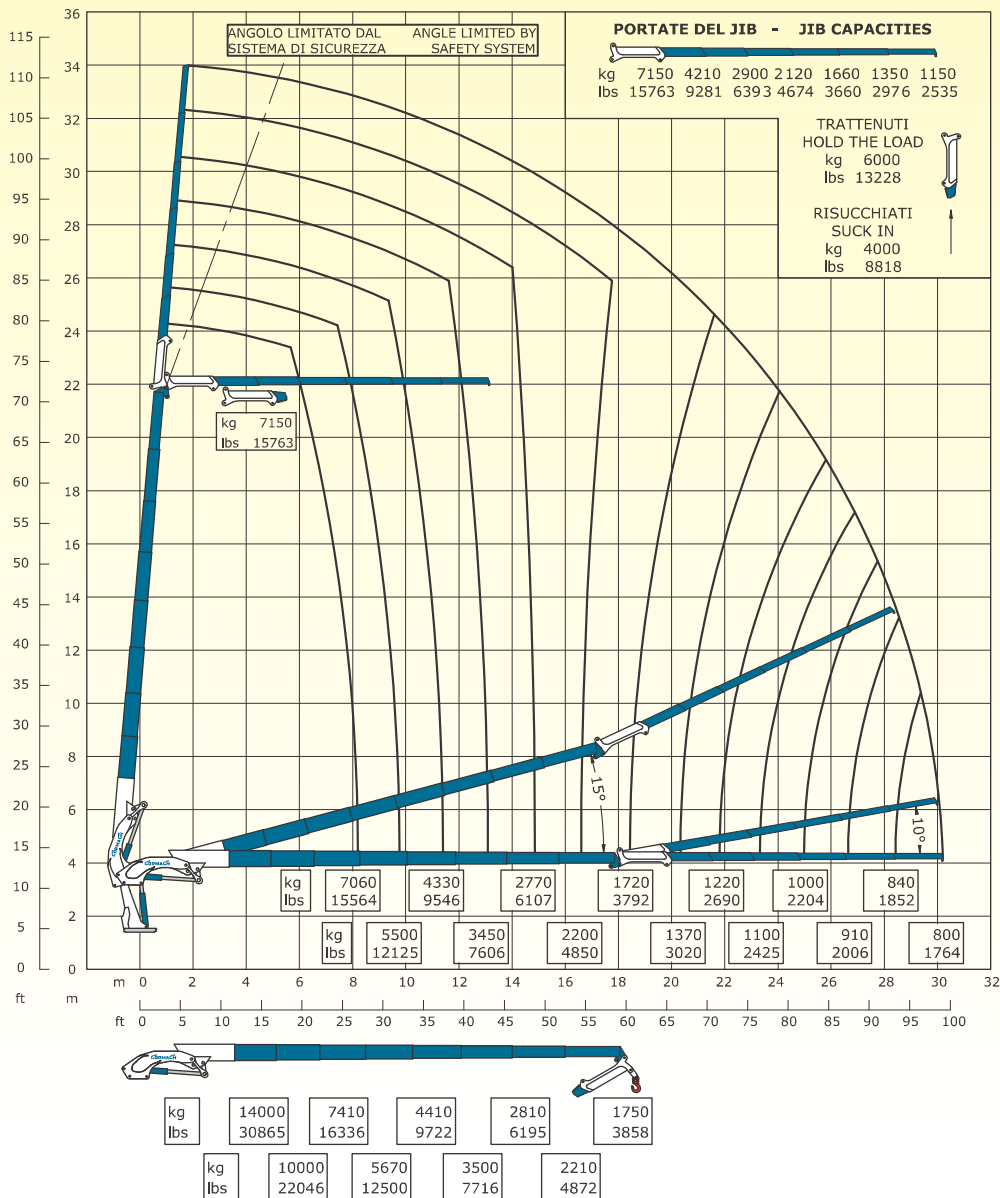

E8F186		
87000 daN*m	629393 Lb*ft	Momento statico massimo al perno torretta – Max. static moment at the turret pin Moment statique max. a l'axe de la tourelle – Max. statisches ubmoment am kranseulenbolzen
30.18 m	99' 0"	Sbraccio idraulico – Hydraulic boom length Longueur du bras hydraulique – Hydraulic reichweite
		Sbraccio con prolunghe manuali – Boom length with manual extension Longueur du bras avec rallonges manuelles – Auslegerlänge
8400 daN*m	60769 Lb*ft	Coppia di rotazione – Slew torque – Moment de rotation – Drehmoment
90 sec 360°	90 sec 360°	Tempo di rotazione – Slewing speed – Temp de rotation – Schwenkgeschwindigkeit
3625+2875 mm	11' 11" + 9' 5"	Uscita stabilizzatori – Outriggers extension – Sortie de bequilles – Breite der Abstützung
8850 mm	29' 0"	Larghezza stabilizzatori – Outriggers width – Largeur des bequilles – Gesamtbreite der Abstützung
1842 mm	6' 1"	Lunghezza – Length – Longueur – Gesamtbreite
2550 mm	8' 4"	Larghezza – Width – Largeur – Breite
2950 mm	9' 8"	Altezza – Height – Hauteur – Höhe
10420 kg	22972 lbs	Peso (senza olio e montaggio) – Weight (without oil and fitting) Poids (sans huile et montage – Gewicht (ohne Öl und ohne)
100 l/min	26 us gal/min	Portata pompa – Pump delivery – Capacité de la pompe – Pumpenleistung
310 bar	4408 psi	Pressione – Pressure – Pression – Druck
260 l	69 us gal	Capacità serbatoio olio – Oil tank capacity – Capacité du réservoir de l'huile – Öl tank inhalt

## STANDARD

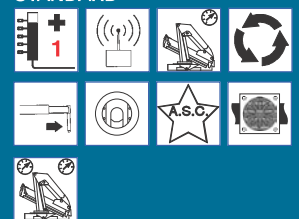

## OPTIONAL

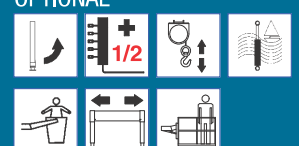

# 87000 E8F186 A.S.C. Plus

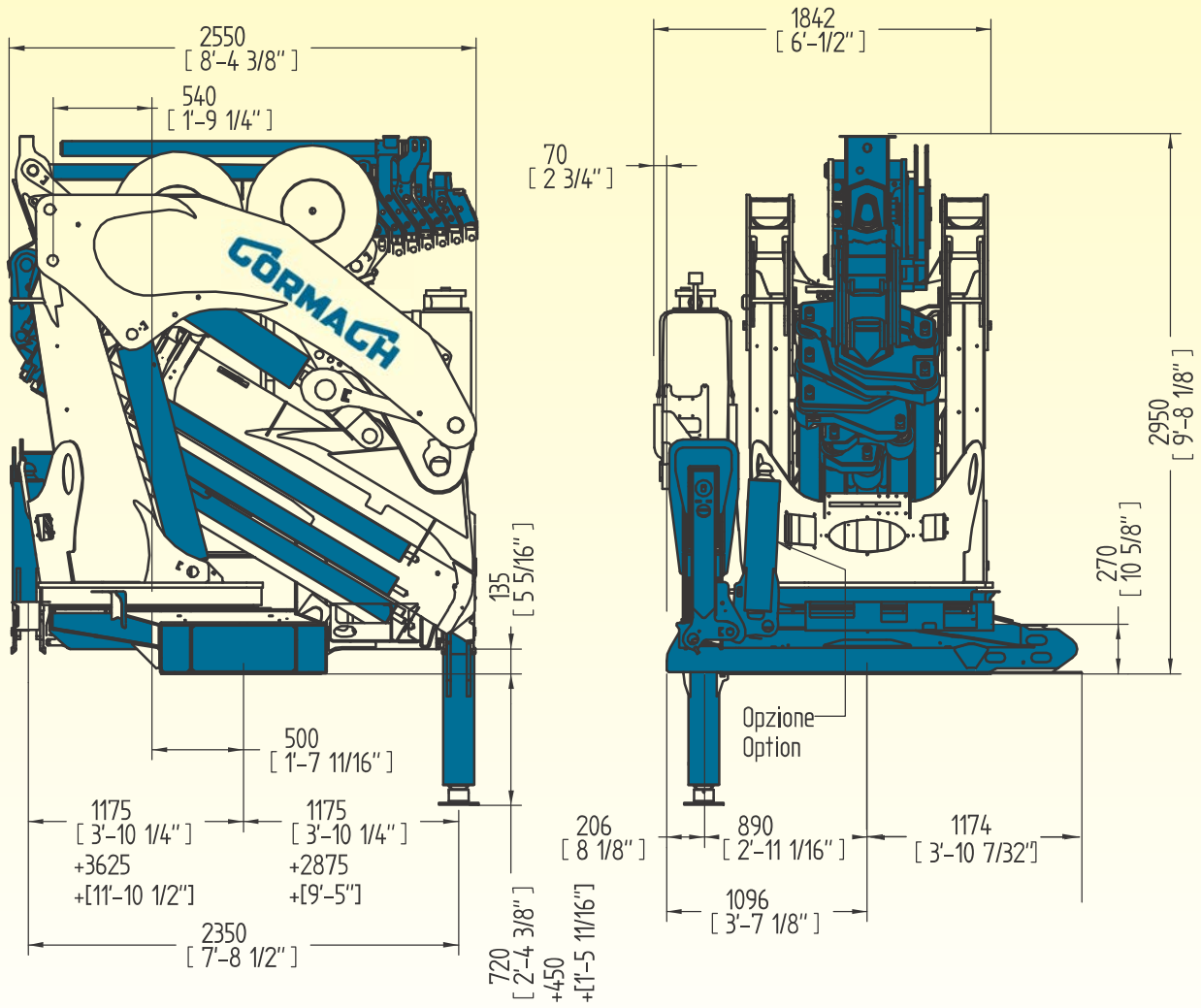







# 87000 E A.S.C. Plus

E2		E3		E4		E5		E6		E7		E8	
m	kg	m	kg	m	kg	m	kg	m	kg	m	kg	m	kg
ft	lbs	ft	lbs	ft	lbs	ft	lbs	ft	lbs	ft	lbs	ft	lbs
3.54	20110	3.66	19300	3.74	18700	3.83	18080	3.95	17370	4.03	16850	4,31	15700
11'7"	44335	12'0"	42550	12'3"	41226	12'7"	39860	13'0"	38294	13'3"	37148	14'3"	34612
5.00	14640	5.13	14060	5.21	13610	5.30	13160	5.42	12650	5.50	12250	5.77	11480
16'5"	32275	16'10"	30997	17'1"	30005	17'5"	29012	17'9"	27888	18'1"	27006	19'1"	25309
6.55	11400	6.67	10930	6.75	10550	6.84	10160	6.96	9750	7.04	9410	7.31	8820
21'6"	25133	21'10"	24096	22'1"	23258	22'5"	22400	22'10"	21495	23'1"	20745	24'0"	19445
		8.27	8900	8.35	8550	8.44	8200	8.56	7830	8.64	7510	8.91	7030
		27'1"	19621	27'4"	18850	27'8"	18077	28'1"	17262	28'4"	16556	29'2"	15498
				10.04	7140	10.13	6810	10.25	6470	10.33	6170	10.60	5750
				32'11"	15741	33'3"	15013	33'7"	14264	33'11"	13602	34'9"	12676
						11.87	5820	12.00	5500	12.07	5200	12.34	4820
						39'0"	12830	39'4"	12125	39'7"	11464	40'6"	10626
								13.80	4780	13.87	4500	14.14	4130
								45'3"	10538	45'6"	9921	46'5"	9105
										15.77	3870	16.04	3510
										51'9"	8532	52'8"	7738
												18.00	3060
												59'0"	6746

## 87000 E11 A.S.C. Plus

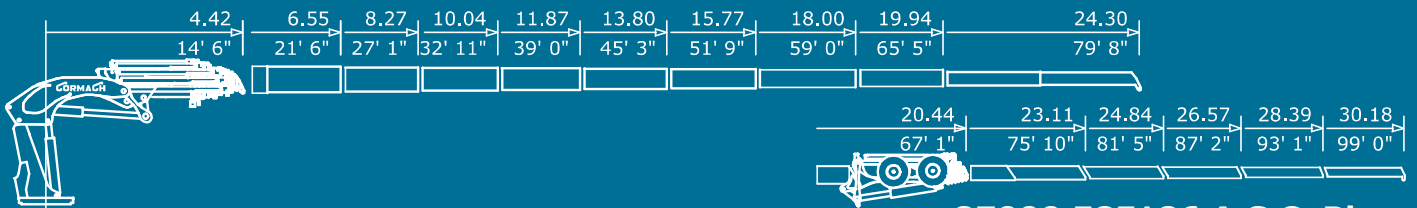

## 87000 E8F186 A.S.C. Plus

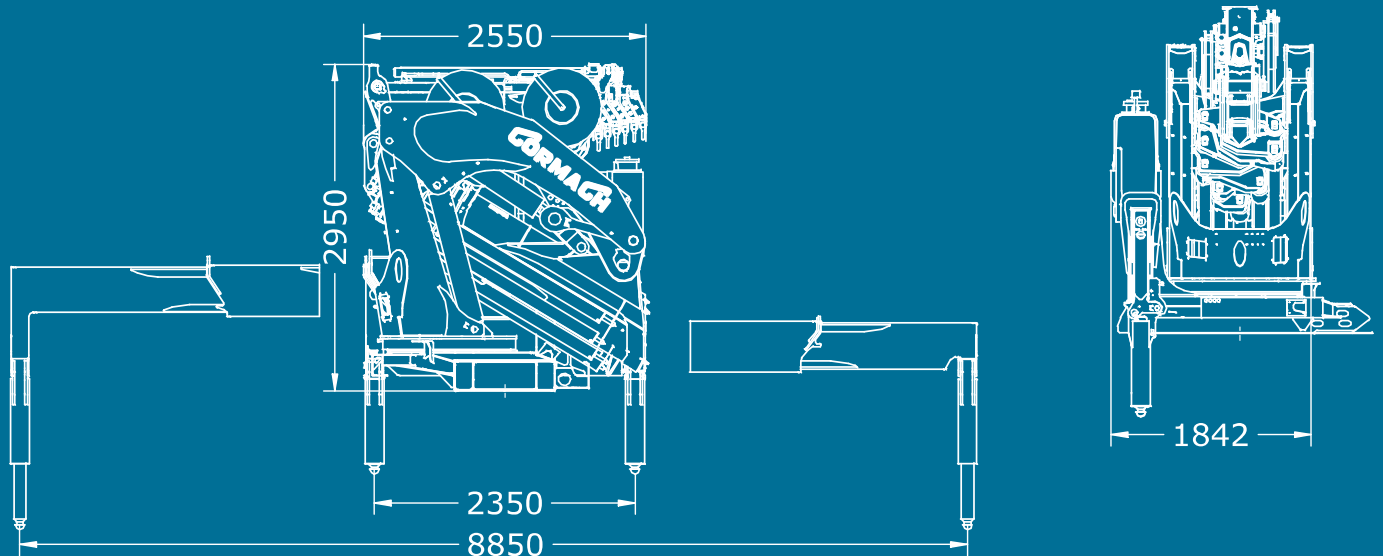

E9		E11		E8F182		E8F183		E8F184		E8F185		E8F186	
m	kg	m	kg	m	kg	m	kg	m	kg	m	kg	m	kg
ft	lbs	ft	lbs	ft	lbs	ft	lbs	ft	lbs	ft	lbs	ft	lbs
4.20	15850	4.42	14860	7.93	7710	8.01	7530	8.09	7350	8.15	7200	8.21	7060
13.9"	34943	14.6"	32760	26.0"	17000	26.3"	16600	26.5"	16204	26.9"	15873	26.11"	15564
5.67	11480	5.89	10780	9.47	6060	9.55	5900	9.63	5750	9.69	5610	9.75	5500
18.7"	25309	19.4"	23765	31.0"	13360	31.4"	13007	31.7"	12676	32.9"	12368	32.0"	12125
7.21	8750	7.43	8180	11.07	4860	11.15	4710	11.23	4570	11.29	4440	11.35	4330
23.8"	19290	24.4"	18033	36.4"	10714	36.7"	10384	36.10"	10075	37.0"	9788	37.3"	9546
8.81	6910	9.03	6420	12.76	3940	12.84	3800	12.92	3670	12.98	3550	13.04	3450
28.11"	15234	29.7"	14153	41.10"	8686	42.2"	8377	42.4"	8091	42.6"	7826	42.9"	7606
10.50	5600	10.72	5150	14.50	3240	14.58	3110	14.66	2980	14.72	2870	14.78	2770
34.5"	12345	35.2"	11354	47.7"	7143	47.10"	6856	48.2"	6570	48.3"	6327	48.6"	6107
12.24	4650	12.46	4220	16.30	2650	16.38	2520	16.46	2400	16.52	2300	16.58	2200
40.2"	10251	40.11"	9303	53.6"	5842	53.9"	5556	54.0"	5291	54.2"	5070	54.5"	4850
14.04	3950	14.26	3530	18.20	2170	18.28	2050	18.36	1930	18.42	1820	18.48	1720
46.1"	8708	46.9"	7782	59.8"	4784	60.0"	4519	60.2"	4255	60.4"	4012	60.7"	3792
15.94	3330	16.16	2930	20.16	1820	20.24	1700	20.32	1570	20.38	1470	20.44	1370
52.4"	7341	53.0"	6460	66.2"	4012	66.5"	3748	66.8"	3461	66.10"	3240	67.1"	3020
17.90	2870	18.12	2500	21.62	1660	21.70	1540	21.78	1420	21.84	1320	21.90	1220
58.9"	6327	59.5"	5511	70.11"	3660	71.2"	3395	71.5"	3131	71.7"	2910	71.10"	2690
19.94	2520	20.16	2150	23.11	1540	23.19	1420	23.27	1300	23.33	1200	23.39	1100
65.5"	5555	66.2"	4740	75.10"	3395	76.1"	3131	76.4"	2866	76.6"	2645	76.9"	2425
		22.23	1900			24.84	1310	24.92	1200	24.98	1080	25.04	1000
		72.11"	4189			81.5"	2888	81.9"	2645	82.0"	2381	82.2"	2204
		24.30	1710					26.57	1100	26.63	1000	26.69	910
		79.8"	3770					87.2"	2425	87.4"	2204	87.7"	2006
										28.39	930	28.45	840
										93.1"	2050	93.4"	1852
												30.18	800
													1764

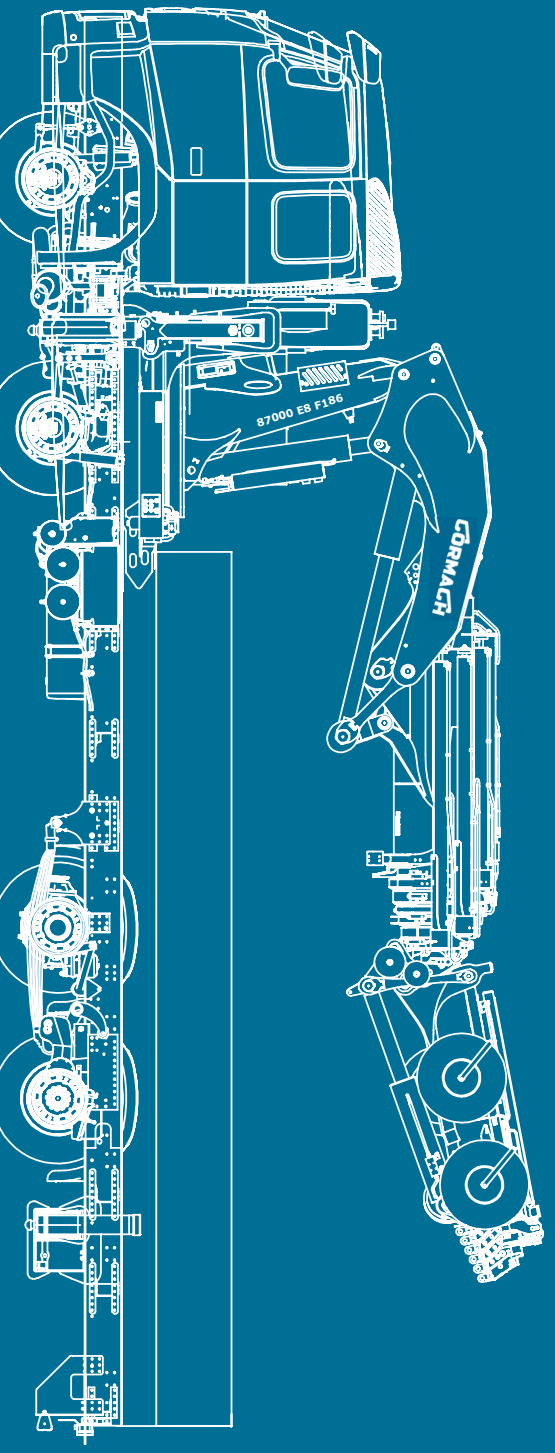



# CORMACH

Cormach s.r.l. - Via Madonnina, 27 - C.P. 199 - 25018 MONTICHIARI (BS) - ITALY  
Tel. 0039.030.9656811 - Telefax 0039.030.9656846.7.8  
E-mail: [info@cormach.com](mailto:info@cormach.com) - [www.cormach.com](http://www.cormach.com)

A fronte di una continua ricerca tecnologica i dati possono cambiare senza preavviso. Contattare il nostro Ufficio Commerciale per ulteriori informazioni.  
Because of continuous technology research data can change without notice. Please, contact our Commercial Dept. for further information.  
A cause de une continue recherche technologique les données peuvent changer sans préavis. Contacter notre Bureau Commercial pour des autres informations.  
Irrtum und technische Änderung vorbehalten in masse und gewichte unverbindlich. Unser Vertrieb erteilt Ihnen gerne weitere Auskünfte. Bitte rufen Sie uns an.  
Debido a los continuos avances tecnológicos los datos pueden variar sin notificación previa. Para más información rogamos contactar nuestro Departamento Comercial.